

PANEL DOORS

Description

مواصفات

- Available in many widths ranging from 90 cm up to 180 cm
- Height 210 cm or customize
- Adjustable frame 16 - 24 cm or 12 - 20 cm
- Re-inforced steel inside
- Insulation material inside
- عدة قياسات من ٩٠ سم إلى ١٨٠ سم
- ارتفاع ٢١٠ سم أو على الطلب
- يمكن تعديل حجم الصندوق من ١٦ - ٢٤ سم أو ١٢ - ٢٠ سم
- مصفح بحديد سميك من الداخل
- مواد عازلة من الداخل

P101



P613



P812



P105
Black



P52



أبواب الأمان

4

LUXDOORS



Fire Rated

Different Models

Different Sizes

Safety

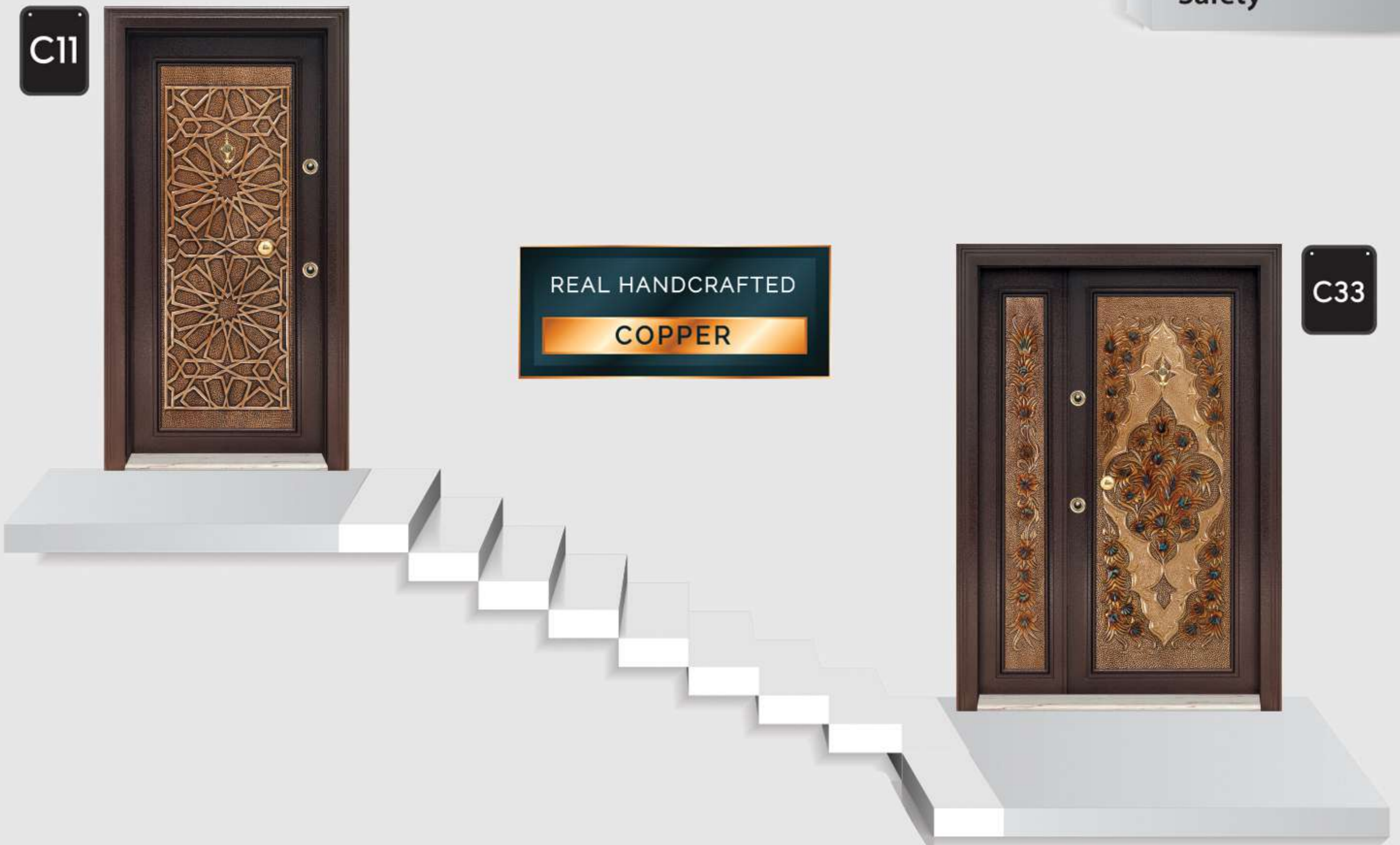

COPPERDOORS



P102



P103



P104



P140
Massif



More Details

- Different Models
- Customized Sizes
- Natural Covering
- Different Colors

Double Leaf

Mini Double Leaf

Single Leaf



P73



LAMINATED DOORS

W410



Weather Proof

The all weather conditions doors!



W411

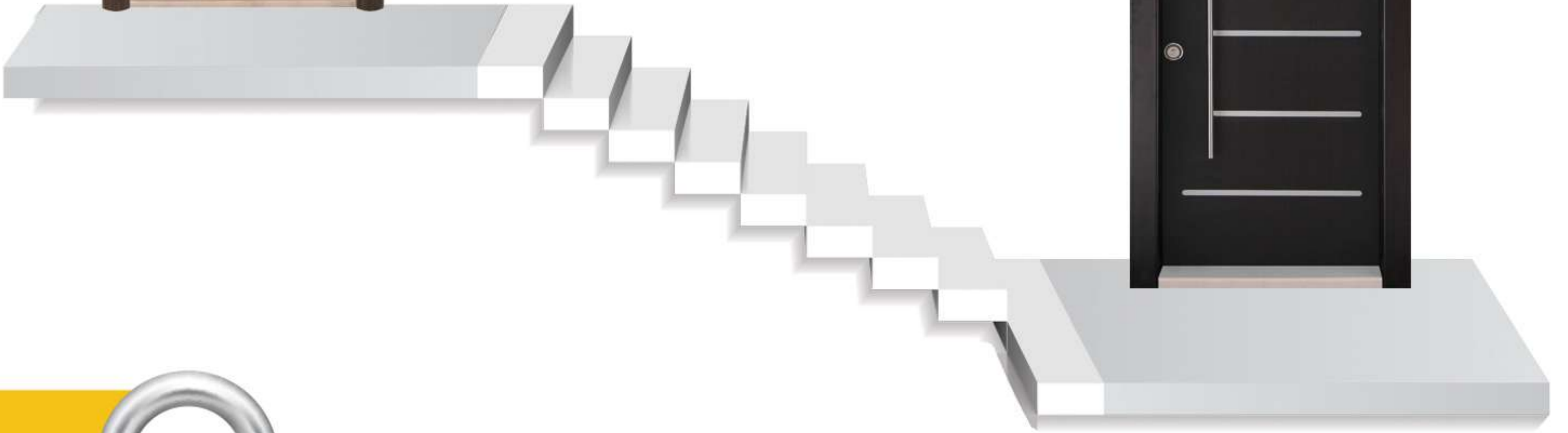

K73

Economic Doors



K24



K37



CLASSIC DOORS

FIRE DOOR

Different sizes and heights.
One Leaf, DBL Leaf

Accessories include door closers, panic bars, door locks, lever handles, door stoppers, anti-smoke rubber, vision panels, and dampers

Electrostatic powder coating
220° Celsius.
Available in different colors
as per RAL catalogs

Hydraulic door closer,
z-frame, adjustable
frame type I & II, half
frame type I & II, fixed
full frame



EXIT



EXIT



EXIT



FIRE EXIT DOORS



STEEL FRAME TYPES

We provide different types of steel frames and made of galvanized steel or powder coated steel.

The Gap between the frames and supports could be filled with grout or fire rated foam.

Catalogs and shop drawings for doors and frames are available upon request.

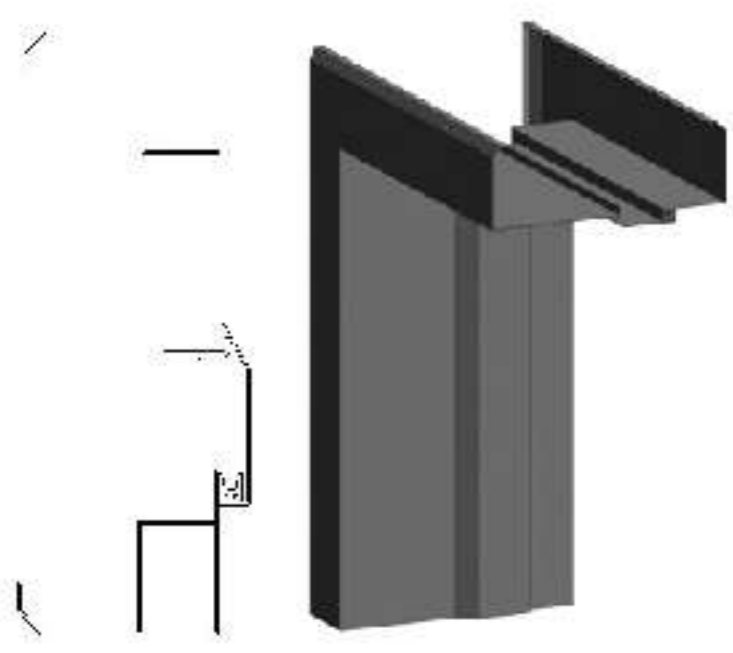

**Adjustable Frame
Type I**

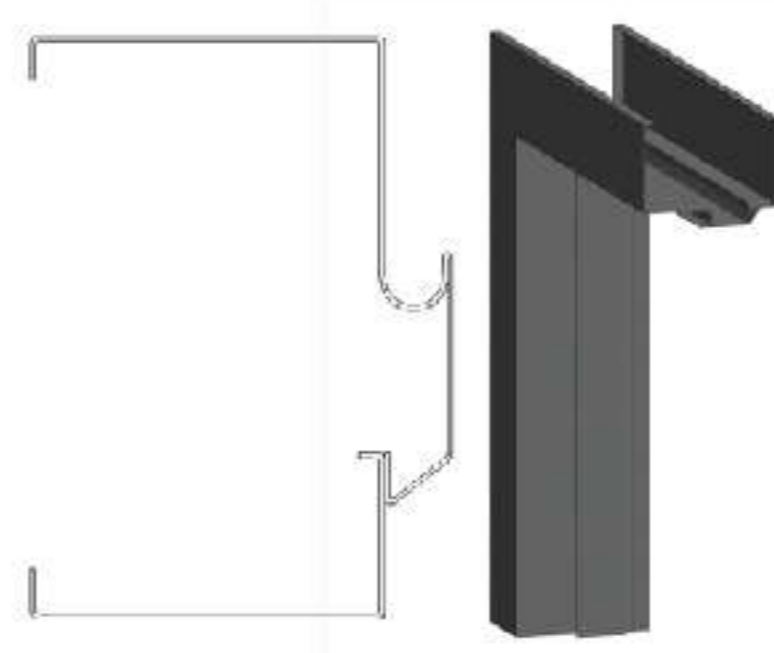

**Adjustable Frame
Type II**

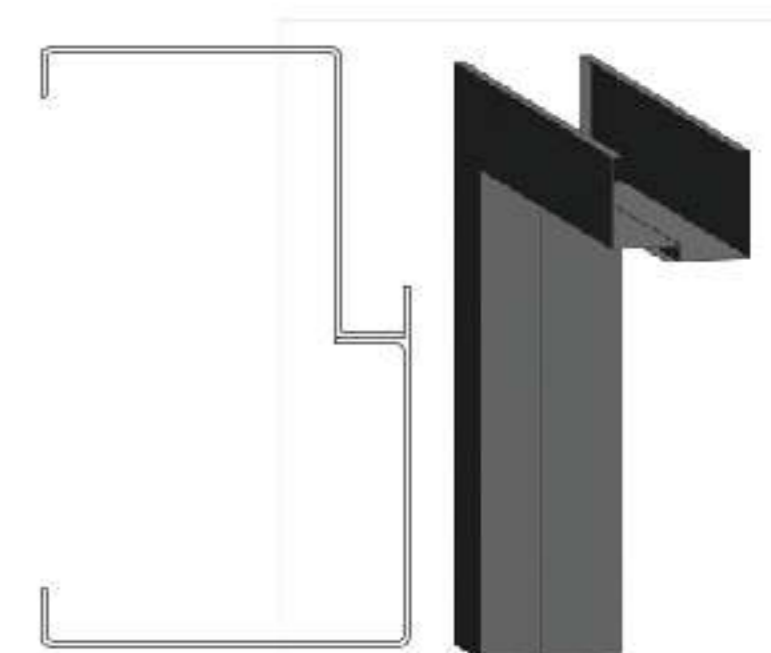

**Fixed Full
Frame**

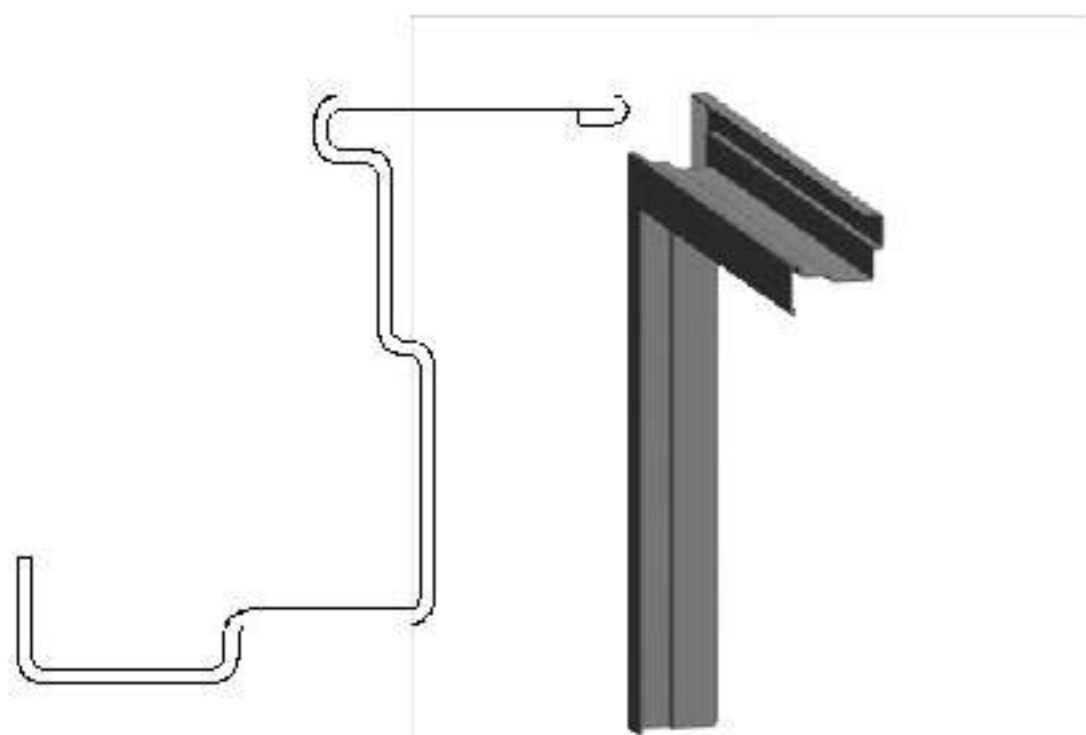

Z Frame

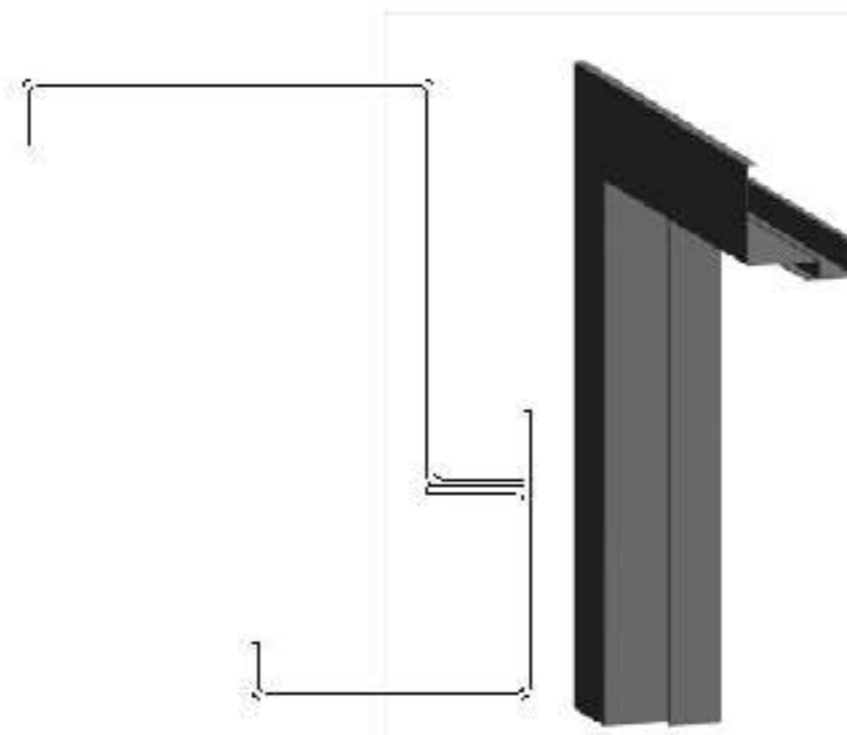

**Half Frame
Type I**

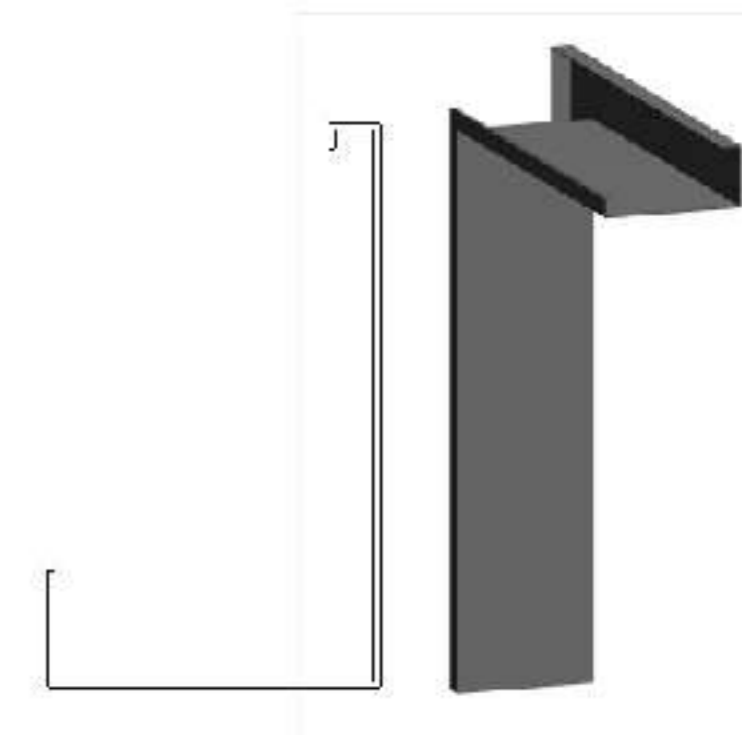

**Half Frame
Type II**

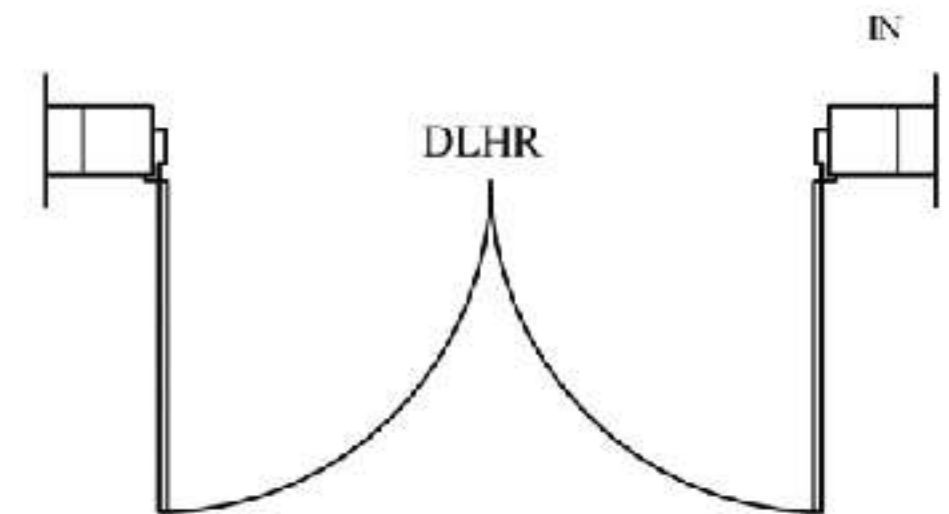
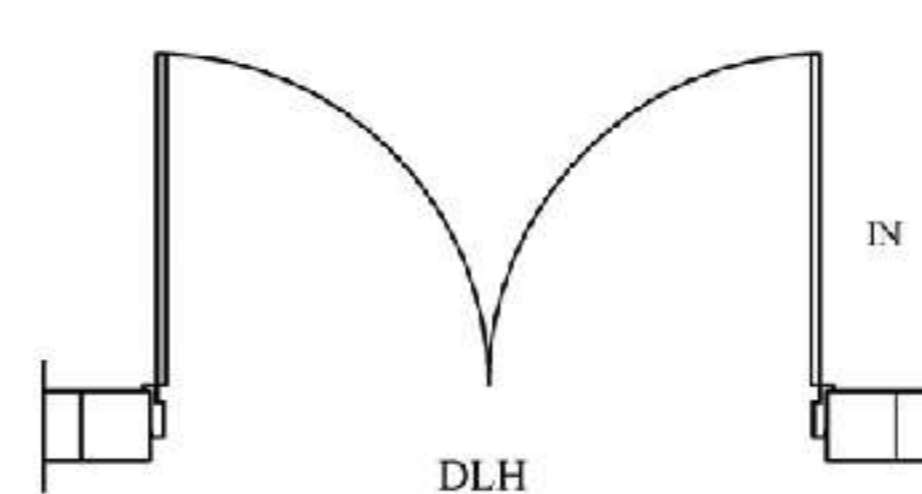
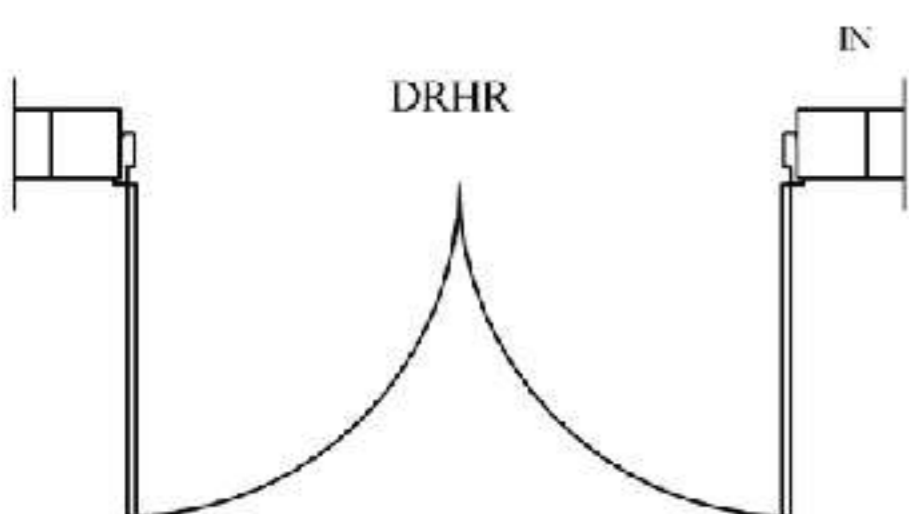
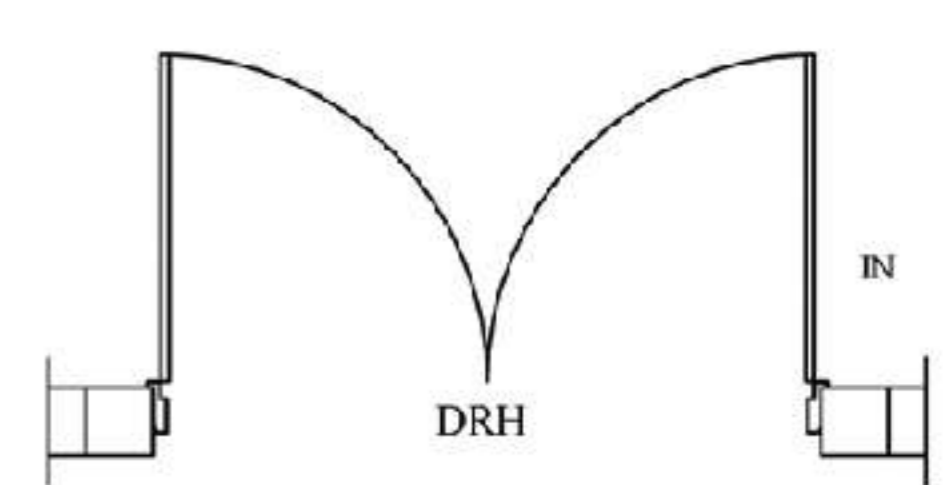
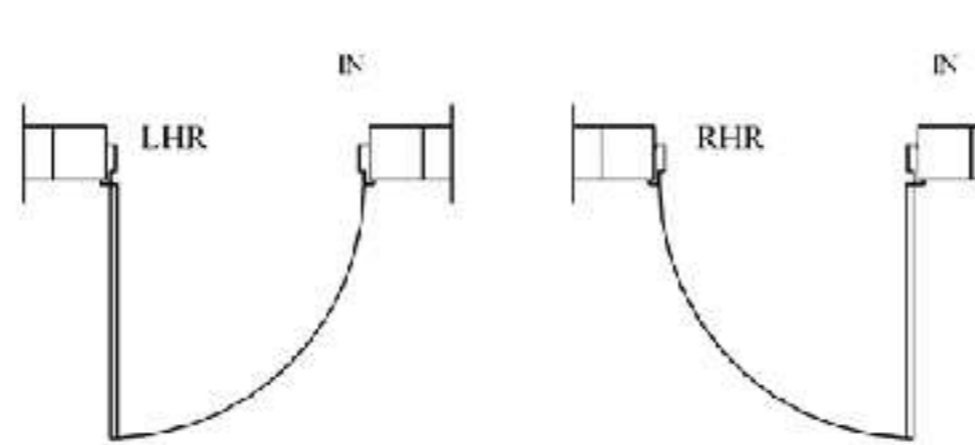
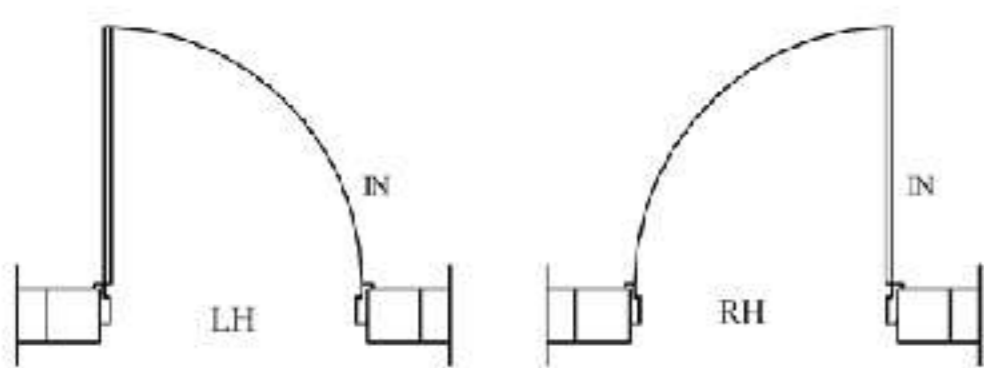

AVAILABLE FIRE RATING

For Doors & Access Panels

- EI 30, 60, 90, 120
- UL 30, 60, 90, 120

AVAILABLE DOOR ACCESSORIES

Our doors are provided with a wide variety of accessories including:

- Door Closers
- Panic Bars
- Door Locks
- Lever Handles
- Door Stoppers
- Anti-smoke rubber
- Vision panels
- Dampers

AVAILABLE SAFETY DOOR ACCESSORIES

Our doors are provided with a wide variety of accessories including:

- Monoblock Locks
- Anti-Smoke Rubber
- Door Stoppers
- Safety Hooks
- Safety Pins
- Knockers
- Multilocks
- Pull Handle
- Viewer



DOOR HANDING DIAGRAM

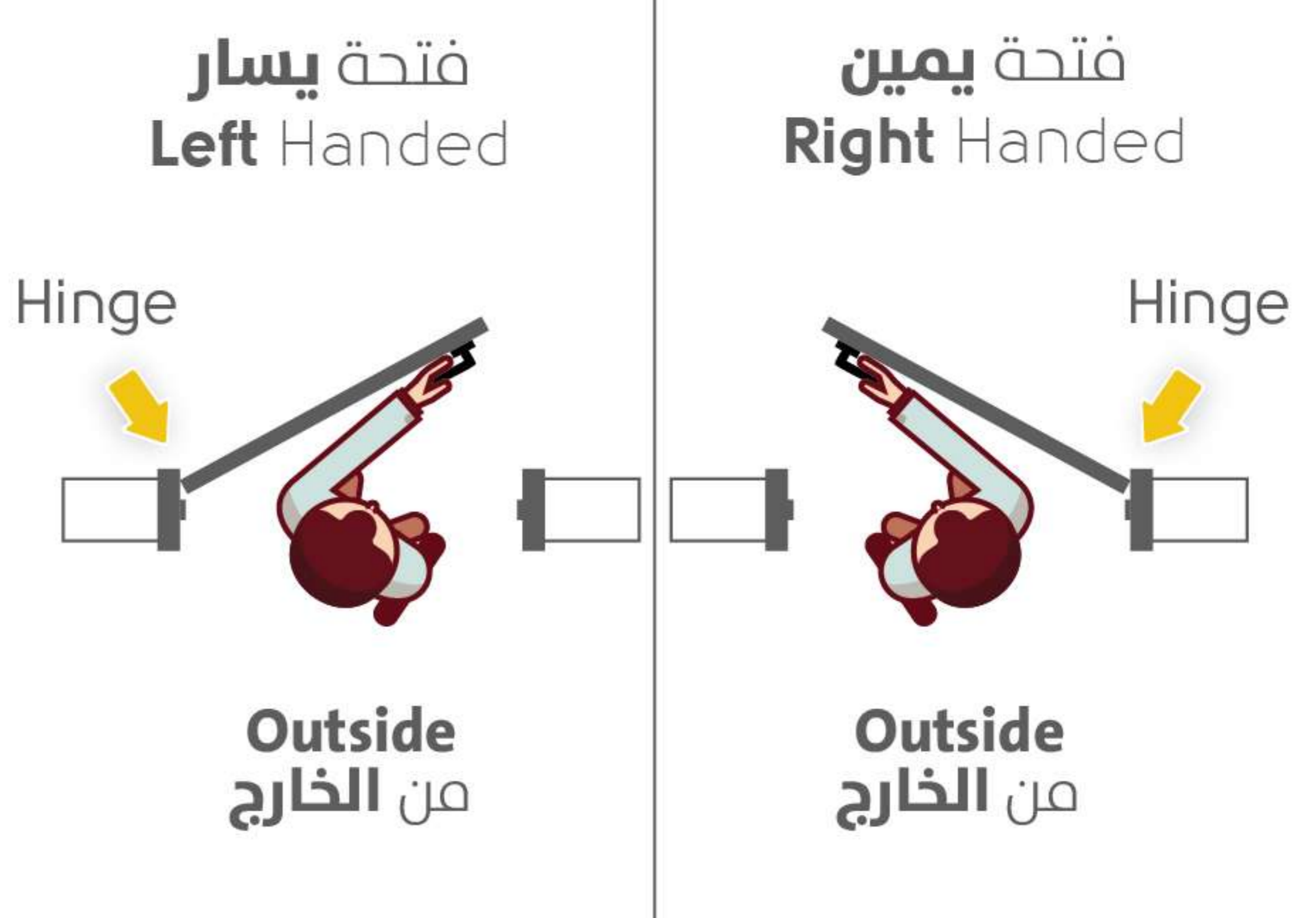

FIRE DOOR

SECURITY DOORS